



AT&T 3G MicroCell™

User Manual



at&t

Table of Contents

IMPORTANT SAFETY INSTRUCTIONS	4
Specifications	5
Welcome	6
Before You Begin.....	6
What's in the Box?.....	6
Getting to Know Your 3G MicroCell	7
Step 1: Online Activation	8
Step 2: Configuration and Powering Up	8
Connect Your Devices with USB Cables?.....	8
Option A – High Speed Internet with Gateway or Modem and Wi-Fi Router.....	9
Option B – High Speed Internet with Modem Attached to Computer.....	10
Option C – Priority Mode Configuration.....	11
Step 3: 3G Status Confirmation	12
Step 4: Final Confirmation	13
What's Next?	13
Troubleshooting	14
Hardware Problems.....	14
Performance Issues	15
Things to Know	16
Frequently Asked Questions (FAQs)	16
FCC Compliance	19
Radiation Exposure Statements	19
One-Year Limited Warranty	Back Cover

IMPORTANT SAFETY INSTRUCTIONS

Notice to Installers

The servicing instructions in this notice are for use by qualified service personnel only. To reduce the risk of electric shock, do not perform any servicing other than that contained in the operating instructions, unless you are qualified to do so.

Note to System Installer

For this apparatus, the cable shield/screen shall be grounded as close as practical to the point of entry of the cable into the building. For products sold in the US and Canada, this reminder is provided to call the system installer's attention to Article 800-93 and Article 800-100 of the NEC (or Canadian Electrical Code Part 1), which provides guidelines for proper grounding of the cable shield.



This symbol is intended to alert you that uninsulated voltage within this product may have sufficient magnitude to cause electric shock. Therefore, it is dangerous to make any kind of contact with any inside part of this product.

Ce symbole a pour but d'alerter toute personne qu'un contact avec une pièce interne de ce produit, sous tension et non isolée, pourrait être suffisant pour provoquer un choc électrique. Il est donc dangereux d'être en contact avec toute pièce interne de ce produit.



This symbol is intended to alert you of the presence of important operating and maintenance (servicing) instructions in the literature accompanying this product.

Ce symbole a pour but de vous avertir qu'une documentation importante sur le fonctionnement et l'entretien accompagne ce produit.



CAUTION: To reduce the risk of electric shock, do not remove cover (or back). No user-serviceable parts inside. Refer servicing to qualified service personnel.

WARNING
TO PREVENT FIRE OR ELECTRIC SHOCK, DO NOT EXPOSE THIS UNIT TO RAIN OR MOISTURE.

20080814_Installer800

- 1) Read these instructions.
- 2) Keep these instructions.
- 3) Heed all warnings.
- 4) Follow all instructions.
- 5) Do not use this apparatus near water.
- 6) Clean only with dry cloth.
- 7) Do not block any ventilation openings. Install in accordance with the manufacturer's instructions.
- 8) Do not install near any heat sources such as radiators, heat registers, stoves, or other apparatus (including amplifiers) that produce heat.
- 9) Do not defeat the safety purpose of the polarized or grounding-type plug. A polarized plug has two blades with one wider than the other. A grounding-type plug has two blades and a third grounding prong. The wide blade or the third prong are provided for your safety. If the provided plug does not fit into your outlet, consult an electrician for replacement of the obsolete outlet.
- 10) Protect the power cord from being walked on or pinched particularly at plugs, convenience receptacles, and the point where they exit from the apparatus.
- 11) Only use attachments/accessories specified by the manufacturer.
- 12) Unplug this apparatus during lightning storms or when unused for long periods of time.

Power Source Warning

A label on this product indicates the correct power source for this product. Operate this product only from an electrical outlet with the voltage and frequency indicated on the product label. If you are uncertain of the type of power supply to your home or business, consult your service provider or your local power company.

The AC inlet on the unit must remain accessible and operable at all times.

Ground the Product



WARNING: Avoid electric shock and fire hazard! If this product connects to cable wiring, be sure the cable system is grounded (earthed). Grounding provides some protection against voltage surges and built-up static charges.

Protect the Product from Lightning

In addition to disconnecting the AC power from the wall outlet, disconnect the signal inputs.

Verify the Power Source from the On/Off Power Light

When the on/off power light is not illuminated, the apparatus may still be connected to the power source. The light may go out when the apparatus is turned off, regardless of whether it is still plugged into an AC power source.

Eliminate AC Mains Overloads



WARNING: Avoid electric shock and fire hazard! Do not overload AC mains, outlets, extension cords, or integral convenience receptacles. For products that require battery power or other power sources to operate them, refer to the operating instructions for those products.

IMPORTANT SAFETY INSTRUCTIONS, continued

Provide Ventilation and Select a Location

- Remove all packaging material before applying power to the product.
- Do not place this apparatus on a bed, sofa, rug, or similar surface.
- Do not place this apparatus on an unstable surface.
- Do not install this apparatus in an enclosure, such as a bookcase or rack, unless the installation provides proper ventilation.
- Do not place entertainment devices (such as VCRs or DVDs), lamps, books, vases with liquids, or other objects on top of this product.
- Do not block ventilation openings.

Protect from Exposure to Moisture and Foreign Objects

 **WARNING: Avoid electric shock and fire hazard! Do not expose this product to dripping or splashing liquids, rain, or moisture. Objects filled with liquids, such as vases, should not be placed on this apparatus.**

 **WARNING: Avoid electric shock and fire hazard! Unplug this product before cleaning. Do not use a liquid cleaner or an aerosol cleaner. Do not use a magnetic/static cleaning device (dust remover) to clean this product.**

 **WARNING: Avoid electric shock and fire hazard! Never push objects through the openings in this product. Foreign objects can cause electrical shorts that can result in electric shock or fire.**

Service Warnings

 **WARNING: Avoid electric shock! Do not open the cover of this product. Opening or removing the cover may expose you to dangerous voltages. If you open the cover, your warranty will be void. This product contains no user-serviceable parts.**

 **WARNING: This device has anti-tampering technology. Attempts to open the enclosure by unqualified personnel may render the device inoperable.**

Check Product Safety

Upon completion of any service or repairs to this product, the service technician must perform safety checks to determine that this product is in proper operating condition.

Protect the Product When Moving It

Always disconnect the power source when moving the apparatus or connecting or disconnecting cables.

20081017_3G_MicroCell_Safety

Specifications

Device Specifications

Power Supply: 100-120 VAC, 15 W; 12 VDC, 1.25 A Output

Status Indicators: Power, Ethernet, GPS, Computer, 3G

Dimensions (H x D x W): 8.5 in. x 6.3 in. x 1.5 in. (at top), 4 in. (at legs)

Unit Weight: 1 lb 2 ounces (AC power adapter not included)

Ambient Temperature Range: 0° to 38°C

Firewall Specifications

System Administrators (Business Customers): Installing the 3G MicroCell behind a firewall, or behind a router with firewall capabilities, requires the following ports be opened to prevent the firewall from blocking communication with the network. This type of installation is typically found in corporate environments.

123/UDP: NTP timing (NTP traffic)

443/TCP: Https over TLS/SSL for provisioning and management traffic

4500/UDP: IPsec NAT Traversal (for all signaling, data, voice traffic)

500/UDP: IPsec Phase 1 prior to NAT detection (after NAT detection, 4500/UDP is used)

4500/UDP: After NAT detection, 4500/UDP is used

Welcome

Congratulations on the purchase of the AT&T 3G MicroCell™. The 3G MicroCell provides voice and data service to AT&T 3G wireless phones and devices within a home or small business environment. The 3G MicroCell is secure and can deliver maximum cellular signal strength within its coverage area – it's like having your own mini cell tower in your home or office.



AT&T recommends that you use the [AT&T 3G MicroCell™ Getting Started Guide](#) for initial setup of your 3G MicroCell. Refer to this User Manual for troubleshooting steps or if you want to configure 'Priority Mode' on your system (see Option C on page 11).

Before You Begin

To operate the 3G MicroCell, you must have the following items:

- High Speed Internet service over DSL or Cable*
- Modem or gateway (a Wi-Fi router is optional)
- Computer with Internet access to register your device
- System Administrators (business customers) see Firewall Specifications on page 5 of this User Manual.
- Please verify these requirements before going any further

Allow **up to 2 hours** to have your 3G MicroCell up and running. Your part (online activation and equipment setup) takes 10-15 minutes. The additional time is for system configuration and 3G service activation. These tasks are handled by the 3G MicroCell and require no effort on your part.

In order to activate your 3G MicroCell you will be required to enter your [AT&T Online Wireless Account user name and password](#). If you have not previously registered for a user name and password, you will be required to do so during the 3G MicroCell setup.

What's in the Box?

- [Remove the contents](#) of the AT&T 3G MicroCell™ package.
- [Verify](#) that you received the following:



AT&T 3G MicroCell™



Getting Started Guide
and User Manual



Yellow
Ethernet Cable



AC Power
Adapter

*Downstream speeds of at least 1.5 Mbps and upstream speeds of at least 256 Kbps are recommended for best performance. There are no restrictions on broadband service providers.

Getting to Know Your 3G MicroCell

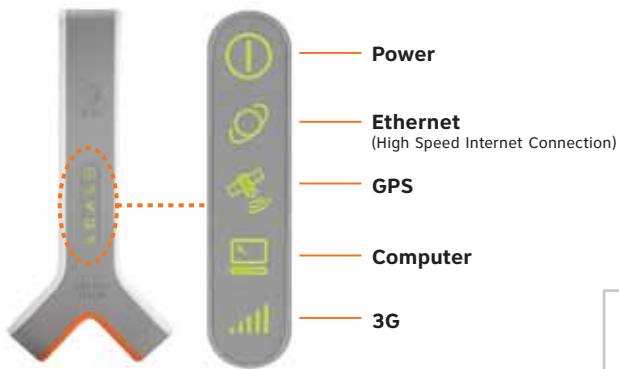

Performance Highlights

- Supports AT&T 3G wireless phones and devices
- Supports up to four simultaneous calls
- Supports call transfer to the cellular network
- Supports UMTS bands 2 & 5 (1900 MHz and 850 MHz)
- Supports E911 Service*

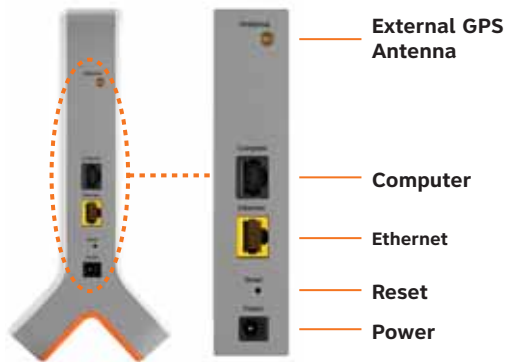

Tip

Visit att.com/3GMicroCell on the web to learn how you and others can use your new 3G MicroCell. The site also contains up-to-date troubleshooting solutions and demos.

* E911 Service

The AT&T 3G MicroCell™ supports E911 (wireless 9-1-1 service) unless the device loses electrical power or Internet access. In the event of a service disruption, you won't be able to use E911 service with your wireless device unless you have access to the AT&T wireless network. It may take several minutes after power resumes for your device to be fully functional. If you move your MicroCell to a new address, it will be necessary to follow the original installation instructions and register the new address online at att.com/3GMicroCell to enable E911 service to function properly.

Step 1: Online Activation

If you haven't already activated your 3G MicroCell when you purchased it, you must do so now.

1. Launch your web browser and visit: att.com/3GMicroCell.
2. Locate the [Activate my AT&T 3G MicroCell™](#) area on the lower portion of the home page and click on the applicable link.
3. When prompted, enter your [AT&T Online Wireless Account](#) user name and password. If you don't have one, follow the [on-screen instructions](#) to create one.
4. Follow the remaining [on-screen steps](#) until you reach the confirmation screen.

Note: As an added benefit, when placing a 911 call while connected to your 3G MicroCell, the full location address you provide in your online activation will be sent to local emergency responders. A built-in Global Positioning System (GPS) feature helps deliver this functionality.



Write down your 3G MicroCell's [serial number](#) as you will need it for online activation and for future reference.

Serial # (S/N):

<input type="text"/>	<input type="text"/>	<input type="text"/>	<input type="text"/>	<input type="text"/>	<input type="text"/>	<input type="text"/>	-	<input type="text"/>	<input type="text"/>	<input type="text"/>	<input type="text"/>	<input type="text"/>	<input type="text"/>	<input type="text"/>	<input type="text"/>	<input type="text"/>	<input type="text"/>	<input type="text"/>	<input type="text"/>	<input type="text"/>
----------------------	----------------------	----------------------	----------------------	----------------------	----------------------	----------------------	---	----------------------	----------------------	----------------------	----------------------	----------------------	----------------------	----------------------	----------------------	----------------------	----------------------	----------------------	----------------------	----------------------

Step 2: Configuration and Powering Up

How you configure your 3G MicroCell is dependent on what equipment you currently use to connect to the Internet.

- If you have either a [gateway](#) or [modem and Wi-Fi router](#), follow [OPTION A on page 9](#).
- If you only have a [modem](#) attached directly to your computer, follow [OPTION B on page 10](#).
- If you have a modem, and a Wi-Fi router and want to prioritize your 3G MicroCell connection because other Internet use impacts the 3G MicroCell's performance, follow our [Priority Mode Configuration](#) which is [OPTION C on page 11](#).

Connect Your Devices with USB Cables?

If you currently use a [USB cable](#) to connect your modem and computer you will no longer be able to do so. You have 2 cabling alternatives:

Alternative A: Remove the USB cable and install Ethernet cables according to Option A, B, or C as described above.

Note: This option requires a second Ethernet cable which is not included in your AT&T 3G MicroCell™ box.

Alternative B: Obtain USB-to-RJ45 adapters (not shown) and install one with the yellow Ethernet cable and the other with your USB cable and then select from Option A, B, or C as described above.



- Place your MicroCell within 3 feet of a window, if possible.
- Make sure your MicroCell is at least 1 foot away from your gateway or modem and Wi-Fi router.
- Refer to FAQ 1.3 on page 16 for additional details on product placement.

Option A

High Speed Internet with Gateway or Modem and Wi-Fi Router

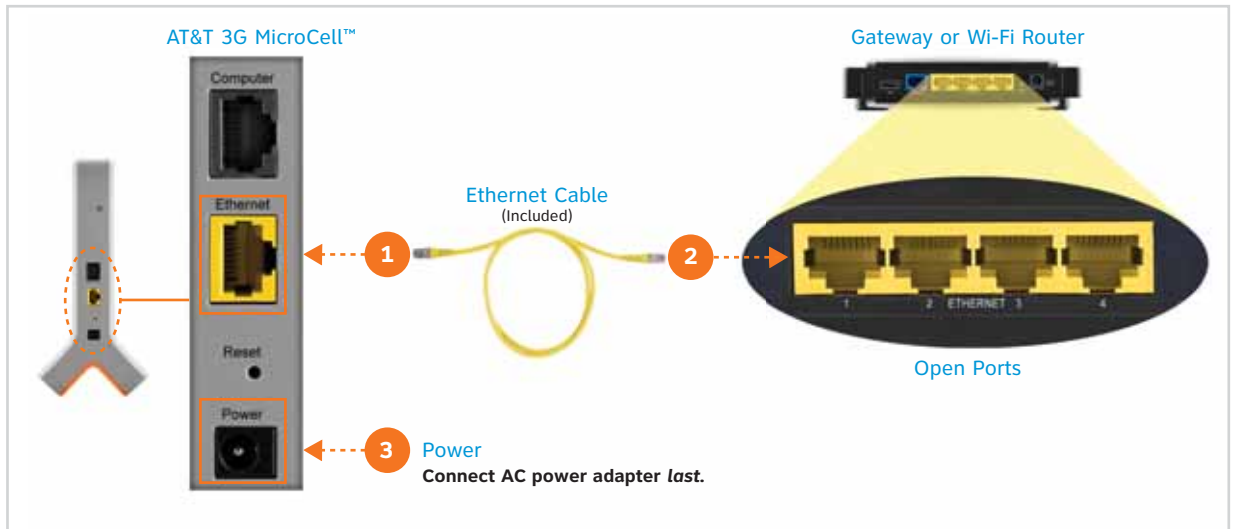

Note: Since you have a gateway or Wi-Fi router, you will NOT need to plug anything into the black port labeled 'Computer' on the 3G MicroCell.

! Remove the sticker that covers the rear panel of your 3G MicroCell.

! To ensure success, it is important to complete the steps below in order.

1. Take the **yellow Ethernet cable** that came with the 3G MicroCell and connect one end to the yellow port labeled **'Ethernet'** on the 3G MicroCell.
2. Connect the other end of the **yellow Ethernet cable** to any open **Ethernet port on your gateway or Wi-Fi router**.
3. First, **turn off power** to your current internet equipment. **Wait 1 minute**, then **turn on power** to your Internet equipment in the following order:
 - a) Gateway or Modem
 - b) Wi-Fi Router (if you have one)
 - c) 3G MicroCell (**Do this last** – connect one end of the **AC Power Adapter** to the port labeled **'Power'** on the 3G MicroCell and connect the other end to an **AC outlet**.)

Advance to page 12.

Option B

High Speed Internet with Modem Attached to Computer

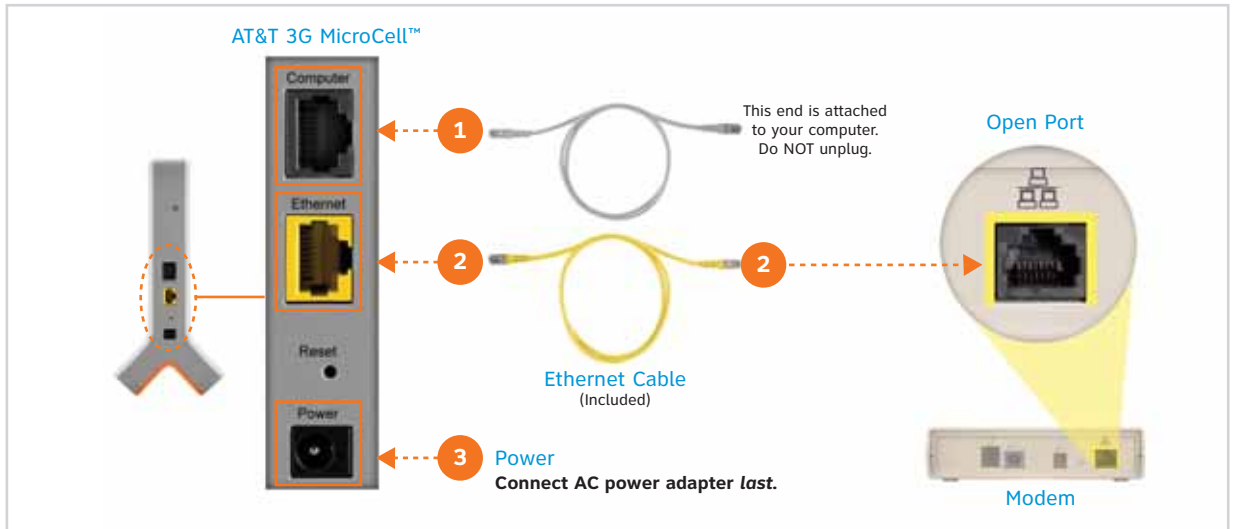

Note: If you normally use a USB cable to connect to your modem and computer, refer to 'Connect Your Devices with USB Cables?' on page 8 for cabling alternatives.

❗ Remove the sticker that covers the rear panel of your 3G MicroCell.

❗ To ensure success, it is important to complete the steps below in order.

1. Disconnect your current Ethernet cable from the modem and reconnect it to the black port labeled 'Computer' on the 3G MicroCell.
2. Take the yellow Ethernet cable that came with the 3G MicroCell and connect one end to the yellow port labeled 'Ethernet' on the 3G MicroCell and the other end to the Ethernet port on your modem.
3. First, turn off power to your current internet equipment. Wait 1 minute, then turn on power to your Internet equipment in the following order:
 - a) Modem
 - b) 3G MicroCell (**Do this last** – connect one end of the AC Power Adapter to the port labeled 'Power' on the 3G MicroCell and connect the other end to an AC outlet.)

Advance to page 12.

Option C

Priority Mode Configuration

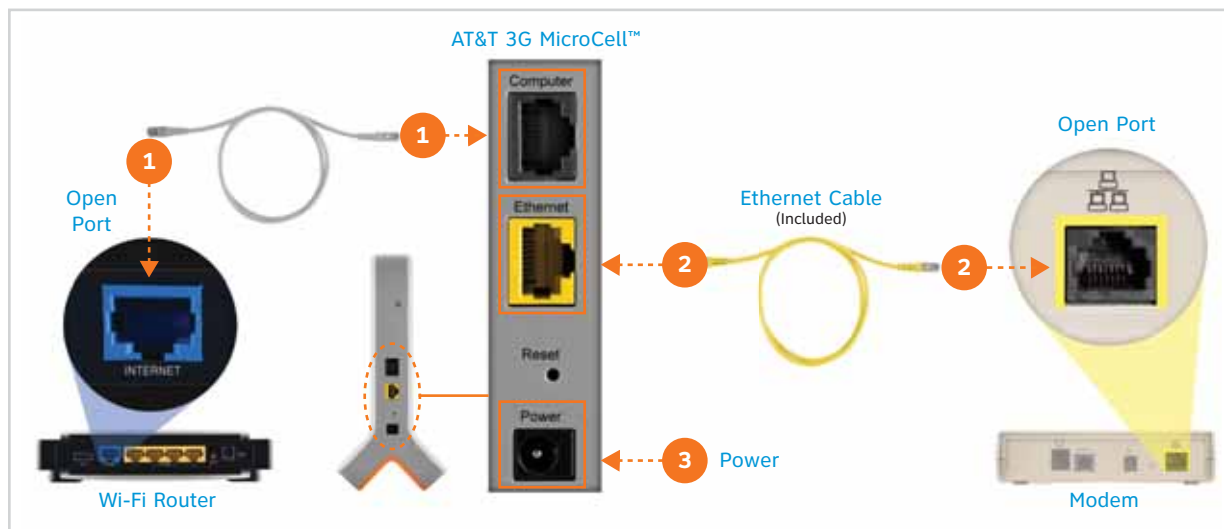

! Remove the sticker that covers the rear panel of your 3G MicroCell.

! To ensure success, it is important to complete the steps below in order.

This setup prioritizes 3G MicroCell connections over computer connections.

1. Connect one end of an **Ethernet cable** to your **Internet port** on your **Wi-Fi router** and the other end of the cable to the port labeled **'Computer'** on your 3G MicroCell.
2. Take the **yellow Ethernet cable** that came with your 3G MicroCell and connect one end to the yellow port labeled **'Ethernet'** on the 3G MicroCell and the other end to the **Ethernet port on your modem**.
3. First, **turn off power** to your current internet equipment. **Wait one minute**, then **turn on power** to your Internet equipment in the following order:
 - a) Modem
 - b) 3G MicroCell (Connect one end of the **AC Power Adapter** to the connector labeled **'Power'** on the 3G MicroCell and connect the other end to an available **AC outlet**.)
 - c) Wi-Fi Router

Advance to page 12.

Step 3: 3G Status Confirmation

1. Make sure the **Power** and **Ethernet** status indicators are **solid green***. If you chose Option B, the **Computer** status indicator will be **solid green** or **flashing green** during data transfer.



Wait 90 minutes. You have completed your part. Relax and give your 3G MicroCell time to complete system configuration and 3G service activation. Do not turn off power or disconnect.

Note: The **GPS** and **3G** status indicators will start **flashing green** within 10 minutes.

2. After 90 minutes, look at your 3G MicroCell front panel status indicators.

* If the Power or Ethernet status indicators are not solid green, see the Troubleshooting section on page 14 for more information.

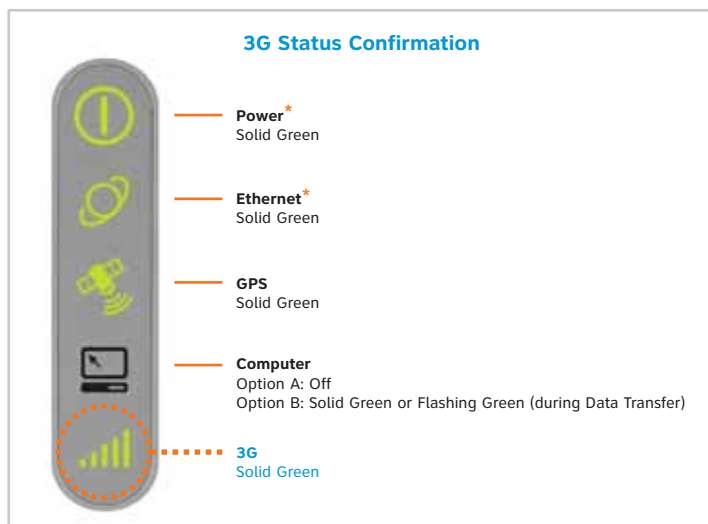

- If the 3G status indicator is **solid green**, 3G activation is complete. You may advance to [Step 4: Final Confirmation](#).
- If the 3G status indicator is **still flashing after 90 minutes**, refer to the steps below for solutions to try.

3G Status Indicator Still Flashing after 90 Minutes?

Try these steps in this order:

1. Confirm that at least **90 minutes** have passed since first powering up the 3G MicroCell.
2. **Power cycle** your 3G MicroCell. (Unplug the power adapter from the wall outlet, wait 10 seconds, then plug it back in.) **Wait 30 minutes** for 3G indicator to go **solid green**.
3. If power cycling doesn't resolve the problem, see [Option C on page 11](#) for an alternative cabling configuration that may provide a solution.
4. If your 3G status indicator still fails to go solid green, see the [Troubleshooting section on page 14](#), or contact AT&T Customer Support at [1.800.331.0500](tel:1.800.331.0500) for assistance.

Step 4: Final Confirmation

You will know that your 3G MicroCell service is up and running when the following occur:

- The 3G MicroCell unit displays a **solid green 3G status**.
- All **AT&T 3G devices** on your **Approved User List** within **range of the 3G MicroCell** display 'AT&T MicroCell'.

You will also be receiving an email and/or text message confirming your activation at the email address and/or primary cell phone number that you entered during online activation.



Tip

Power cycling your 3G handset (turn off/on) may be required if "AT&T MicroCell" or "AT&T M-Cell" does not display on your 3G handset screen. See FAQ 1.9 on page 17 for more information.

Congratulations! You have successfully setup and activated your 3G MicroCell.

What's Next?

You can visit the 3G MicroCell website at att.com/3GMicroCell anytime for further troubleshooting and/or service management topics including:

- Changing your address
- Ordering another 3G MicroCell
- Adjusting your setup configuration







Important E911 Note: The location address you provide in your online activation will be sent to local emergency responders, and must be kept up to date if you move your device. To update your location address information, visit att.com/3GMicroCell and select 'Manage your 3G MicroCell.'

Troubleshooting

Your AT&T 3G MicroCell™ was designed to provide continuous service without intervention on your part. Occasionally, hardware issues and Internet service interruptions can occur that disrupt the operation of the 3G MicroCell. We have provided the following remedial troubleshooting steps so you can find the source of the problem and eliminate it, if possible.

Hardware Problems

Status Indicator	If...	Then...
 Power	The 'Power' status indicator is red.	A hardware fault on the 3G MicroCell has occurred. <ul style="list-style-type: none"> If the 'Power' status remains red, your device may need replacement. Return the device to place of purchase.
 Ethernet	The 'Ethernet' status indicator is off.	There is no physical connection to the 3G MicroCell Ethernet port. <ul style="list-style-type: none"> Confirm that your configuration is correct and that all cables are firmly attached.
	The 'Ethernet' status indicator is flashing.	Cables are connected but no Internet access. <ul style="list-style-type: none"> Steady flashing for less than 3 minutes is normal. If flashing continues for more than 3 minutes, this indicates that there could be an error in your cable configuration. Confirm configuration and recycle power (Off/On) on all devices according to the sequence specified for your configuration option. See Step 2: Configuration and Powering Up on page 8.
 Computer	The 'Computer' status indicator is off.	<ul style="list-style-type: none"> Normal for those with Option A configuration (no Ethernet connection to the 'Computer' port on the 3G MicroCell). For those with Option B or C configurations (a computer or router is connected by Ethernet cable to the 'Computer' port) check that cables are firmly connected.
	The 'Computer' status indicator is flashing green.	Your computer is passing data – this is normal during data transfer.
 GPS	The 'GPS' status indicator is off.	The 3G MicroCell does not have GPS lock. <ul style="list-style-type: none"> It is normal for the status indicator to be off initially when you first power up. Try recycling power (Off/On) on the 3G MicroCell. If the condition does not clear, contact AT&T Customer Support at 1.800.331.0500 for assistance.
	The 'GPS' status indicator is still flashing green after 60 minutes.	The 3G MicroCell cannot acquire a GPS lock. <ul style="list-style-type: none"> If you were never able to get a GPS lock (solid green status) – refer to FAQ 1.3 on page 16. If at any time after you have activated the unit, you notice that the GPS status indicator is flashing green for 60 minutes or more – refer to FAQ 1.3 on page 16. Recycle power (Off/On) on all devices according to the sequence specified for your configuration option. See Step 2: Configuration and Powering Up on page 8.

Troubleshooting, continued

Status Indicator	If...	Then...
	<p>The 3G status indicator is green and flashing.</p>	<p>The unit could be in the midst of the activation process or a software upgrade.</p> <ul style="list-style-type: none"> • While uncommon, it can take up to 60 minutes for your 3G MicroCell to sync with the AT&T system. • Ensure you have a GPS Lock. • You must complete the online activation process – refer to Step 1: Online Activation on page 8. • If you completed the online activation process, there could be network errors preventing activation. You can monitor your activation progress by visiting att.com/3GMicroCell, go to 'Manage your 3G MicroCell', login and view the Device Status field. • Ensure the location address input during the online activation process matches the physical location of your 3G MicroCell. • Recycle power (Off/On) on all devices according to the sequence specified for your configuration option. See Step 2: Configuration and Powering Up on page 8. • If these measures fail, contact AT&T Customer Support at 1.800.331.0500 for assistance.
	<p>The 3G status indicator is red and flashing.</p>	<p>Faults are present on the 3G MicroCell that impact service.</p> <ul style="list-style-type: none"> • Contact AT&T Customer Support at 1.800.331.0500 for assistance.

Performance Issues

If...	Then...
<p>The computer network performance declines.</p>	<p>Traffic across the 3G MicroCell is too heavy.</p> <ul style="list-style-type: none"> • Large wireless data and video file downloads may impact overall network performance.
<p>An AT&T 3G device is unable to access the AT&T 3G MicroCell™ service.</p>	<p>An error is present on your Approved User List.</p> <ul style="list-style-type: none"> • Review your Approved User List by visiting att.com/3GMicroCell, go to 'Manage your 3G MicroCell', and confirm that the phone numbers were entered correctly.
<p>Approved callers are having trouble accessing your AT&T 3G MicroCell™ service.</p>	<p>The 3G MicroCell can only support four simultaneous callers.</p>

Things to Know

! Power cycling the 3G MicroCell and/or your 3G mobile handset can usually resolve minor connectivity issues.

Like many electronic devices, your 3G MicroCell and your 3G phone handset may occasionally need to be “rebooted” to reestablish their connection to each other.

- Unplug the 3G MicroCell’s power adapter from the wall outlet, wait 10 seconds, and plug it back into the wall outlet.
- Turn your 3G handset *fully* off and then turn it back on. (Follow the manufacturer’s instructions for power cycling each 3G device on your Approved User List.)

! Calls transfer out, but don’t transfer in.

Calls seamlessly transfer from the 3G MicroCell to the strongest available AT&T cell tower signal. However, calls initiated on the cell tower do not transfer to the 3G MicroCell.

Note: With Unlimited MicroCell Calling, calls that originate on the 3G MicroCell and transfer to a nearby AT&T cell tower continue on as unlimited.

! Handsets may take some time to switch to the 3G MicroCell.

Your 3G handset may not immediately switch to your 3G MicroCell when you enter its coverage area. Depending on the signal strength of the AT&T cell tower, the time for your handset to switch to the 3G MicroCell can vary. It may take seconds or up to five minutes from the time you enter the 3G MicroCell coverage area.

! Connecting to the 3G MicroCell doesn’t always mean unlimited calling.

You can purchase AT&T Unlimited MicroCell Calling for an individual line or your whole account. If you do not, you will continue to use your existing wireless plan minutes. The same is true for other 3G cell phone owners on your Approved User list; they will continue to use their existing wireless plan minutes unless they also purchase Unlimited MicroCell Calling.

Frequently Asked Questions (FAQs)

1. 3G MicroCell Setup

1.1 I completed online activation at the store when I bought my 3G MicroCell. Do I have to do it again?

No. If you have previously completed online activation in the store, you can skip Step 1: Online Activation.

1.2 I’ve completed online registration and connected my 3G MicroCell according to the instructions and waited 90 minutes, but my 3G status indicator is still flashing and I don’t have 3G service. What should I do?

Power cycle your 3G MicroCell (Unplug the power adapter from the wall outlet, wait 10 seconds, then plug it back in.) Wait 30 minutes for 3G indicator to go solid green.

1.3 What is the purpose of the GPS status indicator on the 3G MicroCell?

Your 3G MicroCell has a built-in Global Positioning System (GPS) feature that helps deliver E911 functionality.

Frequently Asked Questions (FAQs), continued

1.4 Where is the best place to setup my 3G MicroCell to get a GPS signal?

Ideally your 3G MicroCell should be installed in a room within 3 feet of a window and not in a basement or closet.

You will improve the chances for receiving a GPS signal when you install your 3G MicroCell:

- a) above basement level
- b) next to a window with a clear, unobstructed view of the sky (and ideally the window does not contain tinting/film or heavy insulation)
- c) when the sky is clear (You may want to delay MicroCell installation if the sky is cloudy or it is raining)

 It is also important to install your 3G MicroCell at least one foot away from other wireless broadcasting devices (i.e., Wi-Fi) as they may cause interference.

1.5 What should I do if my 3G phone isn't showing the 3G MicroCell (or M-Cell) logo? I've completed online registration, connected the device, and all the indicators on my 3G MicroCell look right.

Power cycle your cell phone by turning it on and off according to the manufacturer's instructions. Wait 15 minutes after power cycling. If your cell phone still doesn't connect to the 3G MicroCell, following the instructions in FAQ 1.2 for power cycling the 3G MicroCell.

1.6 My home office is in the basement – can I still get a GPS signal there?

If there is a window in the room with an unobstructed view of a clear sky, it may be possible. See FAQ 1.4 for ideal criteria.

1.7 I had a solid green GPS Lock, but now it is flashing? What do I do?

If at any time after you have activated the unit, you notice that the GPS status indicator is flashing green for 60 minutes or more, you may need to move the unit closer to the window (within 3 feet of the window) to help with the GPS signal acquisition. If you continue having problems establishing a GPS lock, contact AT&T Customer Support at [1.800.331.0500](tel:1.800.331.0500) for assistance.

1.8 My Computer status indicator on my 3G MicroCell is not lighting up – is that OK?

If you set up your 3G MicroCell according to configuration Option A, the 'Computer' status indicator will not light up. If you set up your 3G MicroCell according to configuration Option B or Option C, the 'Computer' status indicator will be solid green or will flash green when data is being transferred.

1.9 What if I have received an email confirming activation, but I don't see 'AT&T MicroCell' on my 3G handset?

Confirm that the phone number for your 3G handset is on the Approved User list for your 3G MicroCell. If it is, try recycling power (Off/On) on your 3G handset. If you still can't get service, contact AT&T Customer Support at [1.800.331.0500](tel:1.800.331.0500) for assistance.

1.10 I turned on my 3G MicroCell and the GPS and 3G status indicators did not light up – is that OK?

At power-up, it is expected that the GPS status indicator will be off at first for several minutes. It is also not uncommon for the GPS and 3G status indicators to flash green repeatedly while the 3G MicroCell is in the process of activation.

1.11 Why did my 3G MicroCell restart itself during activation?

Your 3G MicroCell was designed to automatically confirm that it has the latest software version each time you power up. If necessary, the 3G MicroCell will then automatically download the latest software. When this occurs, your 3G MicroCell will reset itself, causing the front panel status indicators to turn off and on again and flash during the activation process. This can add up to an additional 15 minutes to the activation process, but will ensure that your 3G MicroCell will have the necessary information for optimal performance.

Frequently Asked Questions (FAQs), continued

1.12 What kind of Internet service do I need?

You need high speed Internet service over DSL or Cable (satellite Internet service will not work). Downstream speeds of at least 1.5 Mbps and upstream speeds of at least 256 Kbps are recommended for best performance. There are no restrictions on broadband service providers.

2. 3G MicroCell Usage and Productivity

2.1 My 3G status indicator on the MicroCell used to be solid green, but now it's flashing and my 3G service isn't working any more. What should I do?

Power cycling the 3G MicroCell can usually resolve minor connectivity issues. Unplug the 3G MicroCell's power adapter from the wall outlet, wait 10 seconds, and plug it back into the wall outlet.

2.2 The AT&T MicroCell (or AT&T M-Cell) logo isn't showing up on my 3G handset screen, even when I hold it right next to the 3G MicroCell. The status indicators on the MicroCell look fine. How do I get the logo back and get my 3G service working again?

Power cycling your 3G mobile handset can usually resolve minor connectivity issues. Turn your 3G handset *fully* off and then turn it back on. (Follow the manufacturer's instructions for power cycling each 3G device on your Approved User List.)

2.3 I have a busy life, with lots of Internet uploads and downloads – is there a way to optimize my service for voice quality?

For those with high Internet traffic and uploads, 'Priority Mode' configuration is an option. To learn more about setting up this configuration, refer to Option C on page 11.

2.4 Can I move my 3G MicroCell to a different street or apartment address?

If you move your 3G MicroCell, you **MUST** update the 3G MicroCell's address. To update your address information, visit att.com/3GMicroCell and go to 'Manage your 3G MicroCell'. Remember, the street and/or apartment address you provide in your online activation will be sent to local emergency responders, so this information must be kept current.

Note: The new location must be in an area where AT&T is licensed to provide service. If you aren't sure, contact AT&T Customer Support at [1.800.331.0500](tel:1.800.331.0500) for assistance.

2.5 Are there any special steps to take if I need to return my 3G MicroCell to AT&T?

Yes, you should disconnect the 3G MicroCell from your account before returning. Visit att.com/3GMicroCell, go to 'Manage your AT&T 3G MicroCell' and follow the online steps for 'Disconnect Your 3G MicroCell Device' from your account.

2.6 I want to give or sell my 3G MicroCell to someone else, is that OK?

Yes, but be sure to disconnect the 3G MicroCell from your account. Otherwise the new owner of the 3G MicroCell will not be able to activate it using his or her account. Visit att.com/3GMicroCell, go to 'Manage your AT&T 3G MicroCell' and follow the online steps for 'Disconnect Your 3G MicroCell Device' from your account.

Note: The new 3G MicroCell owner must contact AT&T Customer Support at [1.800.331.0500](tel:1.800.331.0500) before installing the device. The support representative will explain E911 functionality to ensure that this important feature is understood.

2.7 Do I need to change any settings on my 3G cell phone to make it work with my 3G MicroCell?

No, as long as your 3G cell phone number is on the Approved User List, it will work.

2.8 What cell phones will work with my 3G MicroCell?

Only 3G cell phones that receive wireless service from AT&T will work with the AT&T 3G MicroCell™.

FCC Compliance

United States FCC Compliance

This device has been tested and found to comply with the limits for a Class B digital device, pursuant to part 15 of the FCC Rules. These limits are designed to provide reasonable protection against such interference in a residential installation. This equipment generates, uses, and can radiate radio frequency energy. If not installed and used in accordance with the instructions, it may cause harmful interference to radio communications. However, there is no guarantee that interference will not occur in a particular installation. If this equipment does cause harmful interference to radio or television reception, which can be determined by turning the equipment OFF and ON, the user is encouraged to try to correct the interference by one or more of the following measures:

- Reorient or relocate the receiving antenna, if applicable.
- Increase the separation between the equipment and receiver.
- Connect the equipment into an outlet on a circuit different from that to which the receiver is connected.
- Consult the service provider or an experienced radio/television technician for help.

Any changes or modifications not expressly approved by Cisco Systems, Inc., could void the user's authority to operate the equipment.

The information shown in the FCC Declaration of Conformity paragraph below is a requirement of the FCC and is intended to supply you with information regarding the FCC approval of this device. *The phone numbers listed are for FCC-related questions only and not intended for questions regarding the connection or operation for this device. Please contact your service provider for any questions you may have regarding the operation or installation of this device.*

FCC Declaration of Conformity

This device complies with Part 15 of FCC Rules. Operation is subject to the following two conditions: 1) the device may not cause harmful interference, and 2) the device must accept any interference received, including interference that may cause undesired operation.

AT&T 3G MicroCell™
Model: MicroCell
Manufactured by: Cisco Systems, Inc.
5030 Sugarloaf Parkway
Lawrenceville, Georgia 30044 USA
Telephone: **770-236-1077**

Canada EMI Regulation

This Class B digital apparatus complies with Canadian ICES-003.

Cet appareil numérique de la class B est conforme à la norme NMB-003 du Canada.

This device complies with RSS-132 and RSS-133 of the Industry Canada Rules. Operation is subject to the following two conditions:

- This device may not cause harmful interference.
- This device must accept any interference received, including interference that may cause undesired operation.

20081121 FCC Standard

Software and Firmware Use

The software (including firmware) described in this document is protected by copyright law and furnished to you under a license agreement. You may only use or copy this software in accordance with the terms of your license agreement.

Disclaimer

Cisco Systems, Inc. assumes no responsibility for errors or omissions that may appear in this guide. We reserve the right to change this guide at any time without notice.

Radiation Exposure Statements

Note: This transmitter must not be collocated or operated in conjunction with any other antenna or transmitter. This equipment should be installed and operated with a minimum distance of 7.9 inches (20 cm) between the radiator and your body.

United States

This equipment complies with FCC radiation exposure limits set forth for an uncontrolled environment. This system has been evaluated for RF exposure for humans in reference to ANSI C 95.1 (American National Standards Institute) limits. The evaluation was based on evaluation per ANI C 95.1 and FCC OET Bulletin 65C rev 01.01. The minimum separation distance from the antenna/radiator to a general bystander is 7.9 inches (20 cm) to maintain compliance.

This transmitter must not be collocated or operating in conjunction with any other antenna or transmitter.

The availability of some specific channels and/or operational frequency bands are country dependent and are firmware programmed at the factory to match the intended destination. The firmware setting is not accessible by the end user.

Canada

This equipment complies with IC radiation exposure limits set forth for an uncontrolled environment. This system has been evaluated for RF exposure for humans in reference to ANSI C 95.1 limits. The evaluation was based on evaluation per RSS-102 Rev 2. The minimum separation distance from the antenna to general bystander is 7.9 inches (20 cm) to maintain compliance.



One-Year Limited Warranty

AT&T warrants to the first retail purchaser of this 3G MicroCell device that should this product or any part be proved defective in materials or workmanship, from date of purchase, as evidenced by a register receipt or other valid proof of purchase for a period of one (1) year, then it will be subject to the terms of this one-year limited warranty. Such defects will be repaired or replaced without charge for parts or labor directly related to the defect.

Limitations and Exclusions: This warranty does not apply to any cost incurred for removal or reinstallation, or to any product or part thereof which has suffered through normal wear and tear, alteration, improper installation, physical abuse, misuse, neglect or accident. Nor does it cover defects caused by shipment to an AT&T service center, or repair or service of the product by anyone other than an AT&T service center. Damage resulting from an act of God, including but not limited to fire, flood, earthquake and other natural disasters will be excluded. This limited warranty is in lieu of all other warranties, express or implied either in fact or by operations of law, statutory or otherwise, including, but not limited to, any implied warranty of merchantability or fitness for a particular use. AT&T does not authorize any other person to assume any liability beyond the warranty herein described. In no event, whether based in contract, tort or any other legal theory, shall AT&T or any of its agents or sellers be liable for incidental, consequential, indirect, special, or punitive damages of any kind resulting from the use of this product, including but not limited to interrupted or incomplete phone calls, omission or negligence arising out of any breach of this warranty. In no event shall AT&T or its agents or sellers be liable for any damages however defined in an amount in excess of the purchase price.



Cisco Systems, Inc.
5030 Sugarloaf Parkway, Box 465447
Lawrenceville, GA 30042

678.277.1000
www.cisco.com

Cisco, Cisco Systems, the Cisco logo, and the Cisco Systems logo are activated trademarks or trademarks of Cisco Systems, Inc. and/or its affiliates in the United States and certain other countries.

AT&T, the AT&T logo, and AT&T 3G MicroCell are trademarks of AT&T Knowledge Ventures.

All other trademarks mentioned in this document are the property of their respective owners.

Product and service availability is subject to change without notice.

© 2009 Cisco Systems, Inc. All rights reserved.

December 2009

Part Number 4030453 Rev D